

1 RoHS Compliant 2 Customer Drawing

REV.	ECN NO.	DESCRIPTION	DATE	DESIGN

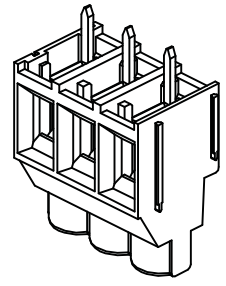
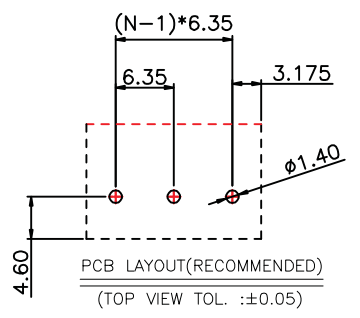

SPECIFICATION MATERIAL

Housing:PA66,UL94V-0
Screw:M3 Steel,Zinc Plated
Terminal:Brass,Tin Plated
Clamp:Brass,Ni Plated
ELECTRICAL
Rated voltage:300V
Rated current:30A
Wire Range(AWG/MM²):24-10AWG/0.2-6MM²
Withstanding voltage:AC2500V/1Min
MECHANICAL
Torque:0.5Nm(4.4Lb-In.)
Strip Length:8mm
Operating Temperature:-40°C~+105°C

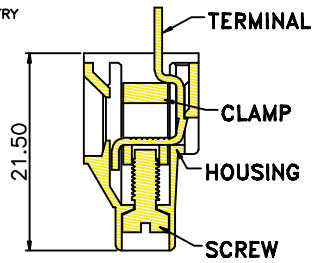
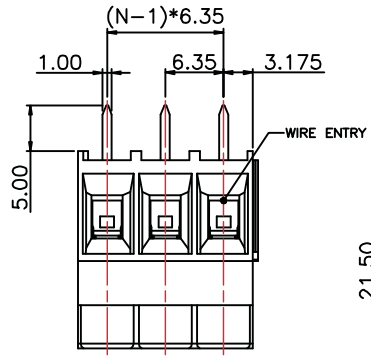
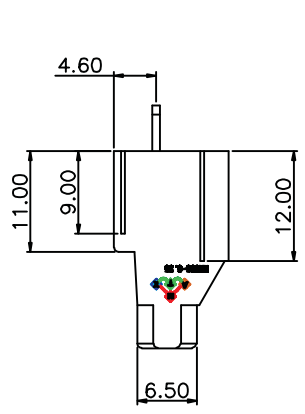

订购方式/HOW TO ORDER

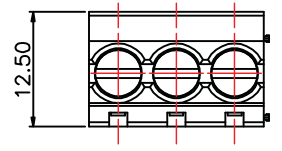
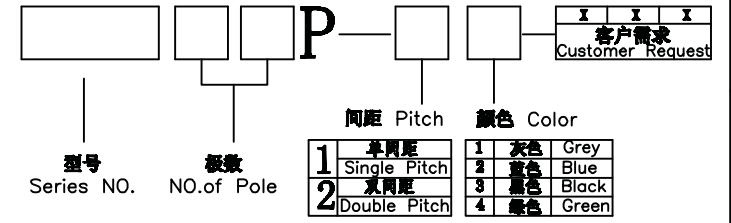

N=No. of contacts

Contact Us

TEL: +86-574-63510149 FAX: +86-574-63516735
 E-Mail: Sales@cxsuteng.com Website: www.cxsuteng.com

公差一览表 TOLERANCE UNLESS OTHERWISE				慈溪市速腾电子有限公司 SUTOWN CIXI SUTENG ELECTRONIC CO., LTD					
X.	±0.25	X°	±5°	单位 UNITS	mm	制图 DRAWING	No.01	产品名称 TITLE	ST635—6.35
.X	±0.20	.X°	±2°	角法 VIEW	第一角法	设计 DESIGN	No.06		
.XX	±0.15	.XX°	±1°	比例 SCALE	1:1	审核 CHKD		产品料号 PART NO.	ST635—6.35
.XXX	±0.02	.XXX°	±0.5°	日期 DATE	2012. 07. 10	版本 APPD	AO	图号 DRAW NO.	ST635—6.35